

FEHLING...

... THE DIFFERENCE

6

CERAMO®

PUNCHES
RONGEURS
BONE CUTTERS

STANZEN
RONGEURE
KNOCHENSCHNEIDER

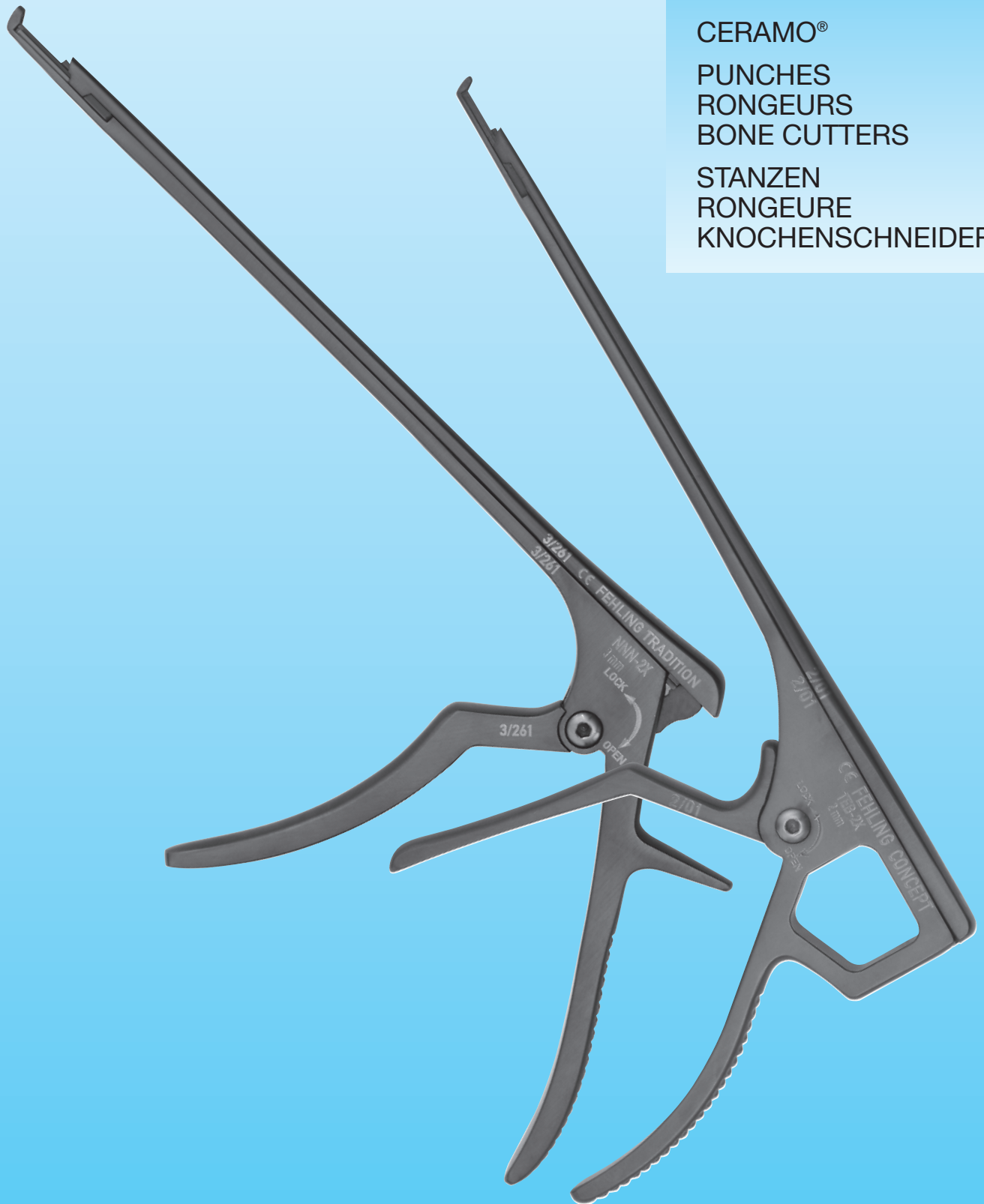

FEHLING
INSTRUMENTS

Hanauer Landstr. 7A · 63791 Karlstein/Germany · www.fehling-instruments.de



+49 (0) 61 88 - 95 74.40



+49 (0) 61 88 - 95 74.45





info@fehling-instruments.de

CERAMO® **CONCEPT X**

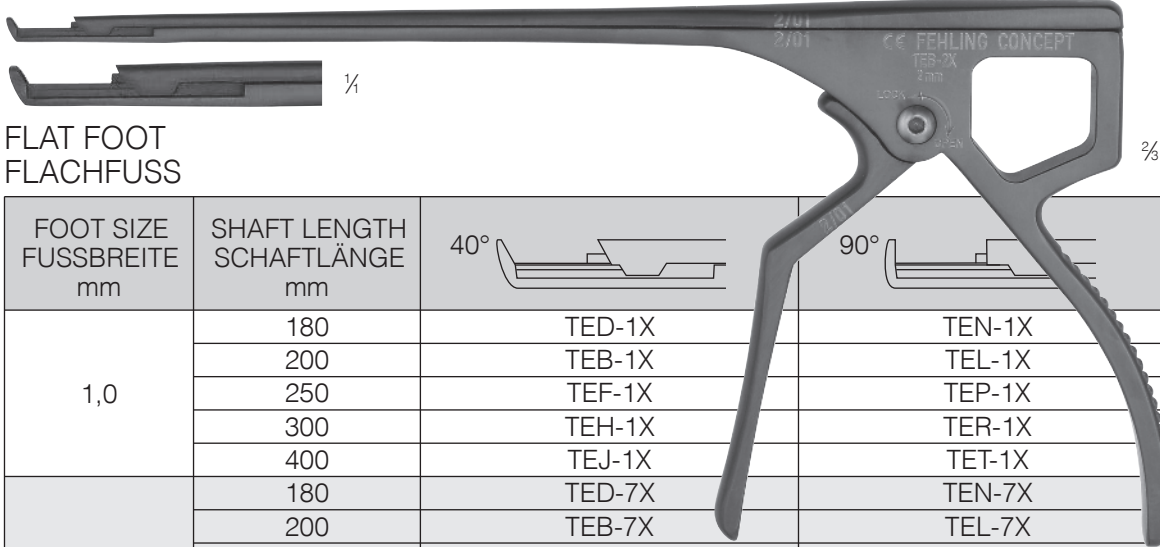
DETACHABLE / ZERLEGBAR

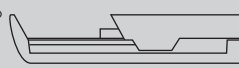

FLAT FOOT
FLACHFUSS



FOOT SIZE FUSSBREITE mm	SHAFT LENGTH SCHAFTLÄNGE mm	40°		90°	
					
1,0	180	TED-1X	TEN-1X		
	200	TEB-1X	TEL-1X		
	250	TEF-1X	TEP-1X		
	300	TEH-1X	TER-1X		
	400	TEJ-1X	TET-1X		
1,5	180	TED-7X	TEN-7X		
	200	TEB-7X	TEL-7X		
	250	TEF-7X	TEP-7X		
	300	TEH-7X	TER-7X		
	400	TEJ-7X	TET-7X		
2,0	180	TED-2X	TEN-2X		
	200	TEB-2X	TEL-2X		
	250	TEF-2X	TEP-2X		
	300	TEH-2X	TER-2X		
	400	TEJ-2X	TET-2X		
2,5	180	TED-8X	TEN-8X		
	200	TEB-8X	TEL-8X		
	250	TEF-8X	TEP-8X		
	300	TEH-8X	TER-8X		
	400	TEJ-8X	TET-8X		
3,0	180	TED-3X	TEN-3X		
	200	TEB-3X	TEL-3X		
	250	TEF-3X	TEP-3X		
	300	TEH-3X	TER-3X		
	400	TEJ-3X	TET-3X		
3,5	180	TED-9X	TEN-9X		
	200	TEB-0X	TEL-9X		
	250	TEF-9X	TEP-9X		
	300	TEH-9X	TER-9X		
	400	TEJ-9X	TET-9X		
4,0	180	TED-4X	TEN-4X		
	200	TEB-4X	TEL-4X		
	250	TEF-4X	TEP-4X		
	300	TEH-4X	TER-4X		
	400	TEJ-4X	TET-4X		
5,0	180	TED-5X	TEN-5X		
	200	TEB-5X	TEL-5X		
	250	TEF-5X	TEP-5X		
	300	TEH-5X	TER-5X		
	400	TEJ-5X	TET-5X		
6,0	180	TED-6X	TEN-6X		
	200	TEB-6X	TEL-6X		
	250	TEF-6X	TEP-6X		
	300	TEH-6X	TER-6X		
	400	TEJ-6X	TET-6X		

CERAMO® **TRADITION X**

DETACHABLE / ZERLEGBAR

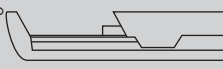

STANDARD FOOT
STANDARDFUSS



FOOT SIZE FUSSBREITE mm	SHAFT LENGTH SCHAFTLÄNGE mm	40° 	40° 	90° 
0,8	200	NNB-9X	-	-
1,0	180	NYC-2X	TRD-1X	-
	200	NNN-0X	-	-
	250	NZY-6X	-	-
	300	NYA-0X	-	-
1,5	180	NYC-1X	-	-
	200	NTI-0X	-	-
2,0	180	NNG-1X	TRD-2X	-
	200	NNY-0X	NNZ-8X	NVB-7X
	250	NNG-7X	-	-
	300	NNG-8X	-	-
	400	NNG-9X	-	-
2,5	200	NNN-1X	-	NNK-2X
	250	NNL-2X	-	-
	300	NNE-2X	NNF-6X	NNE-6X
	400	NNY-2X	NNX-5X	NNV-5X
3,0	180	NNL-7X	TRB-8X	-
	200	NNN-2X	NNN-7X	NNK-3X
	250	NNL-3X	NTI-1X	-
	300	NNE-3X	NNF-7X	NNE-7X
3,5	400	NNY-3X	NNX-6X	NNV-6X
	200	NNN-3X	TNC-3X	TNC-5X
	180	NNL-8X	TRB-9X	-
	200	NNN-4X	NNN-8X	NNK-4X
4,0	250	NNL-4X	-	-
	300	NNE-4X	NNF-8X	NNE-8X
	400	NNY-4X	NNX-7X	NNV-7X
	180	NNL-9X	TRC-0X	-
5,0	200	NNN-5X	NNN-9X	NNK-5X
	250	NNL-5X	-	-
	300	NNE-5X	NNF-9X	NNE-9X
	400	NNY-5X	NNX-8X	NNV-8X
6,0	180	NVC-0X	-	-
	200	NNN-6X	-	-
	250	NNQ-9X	-	-
	300	NNE-0X	NNG-0X	NNH-0X
	400	NNY-6X	NNX-9X	NNV-9X

CERAMO® **TRADITION X**

DETACHABLE / ZERLEGBAR

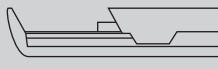

FLAT FOOT
FLACHFUSS

FOOT SIZE FUSSBREITE mm	SHAFT LENGTH SCHAFTLÄNGE mm	40° 	40° 	90° 
1,0	180	NVU-0X	TRB-6X	TRB-5X
	200	NZY-8X	TRB-0X	-
	250	NZY-9X	-	-
	300	NYB-0X	-	-
	400	-	-	NTI-2X
2,0	180	NVF-7X	TRB-7X	-
	200	NNR-0X	NTH-7X	-
	250	NNL-1X	-	-
	300	NNX-0X	NVE-8X	-
	400	NVF-9X	-	-
2,5	180	NVF-2X	-	-
	200	NNO-1X	NNO-4X	NNJ-9X
	250	NNK-8X	-	-
	300	NNW-2X	NNT-6X	-
	400	NNQ-0X	-	NND-6X
3,0	180	NVF-3X	-	-
	200	NNO-2X	NNO-5X	NNK-0X
	250	NNL-6X	-	-
	300	NNW-3X	NNT-7X	-
	400	NNQ-1X	NNQ-6X	NND-7X
3,5	180	NYC-5X	-	-
	200	NNO-8X	-	-
4,0	180	NVF-4X	-	-
	200	NNO-3X	NNO-6X	NNK-1X
	250	NNK-9X	-	-
	300	NNW-4X	NNT-8X	-
	400	NNQ-2X	-	NND-8X
5,0	180	NVF-8X	-	-
	200	NNO-7X	NNO-9X	-
	250	NNL-0X	-	-
	300	NNW-5X	NNT-9X	-
	400	NNQ-3X	-	NND-9X
6,0	200	NNO-0X	-	-

CERAMO® **TURNUS***
ROTATABLE SHAFT
DREHBARER SCHAFT

HANDLES / GRIFFE



CONCEPT

TGZ-0



TRADITION

TGZ-6A

*WARNING: Please use CONCEPT TURNUS punches for cervical and transspenoidal surgery only.

*ACHTUNG: CONCEPT TURNUS Stanzen sind ausschließlich für die Chirurgie der Halswirbelsäule und der Hypophyse ausgelegt.

CERAMO® **TURNUS***

ROTATABLE SHAFTS / DREHBARE SCHÄFTE

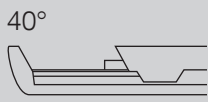
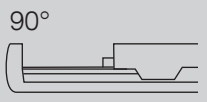
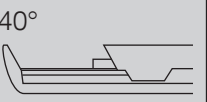
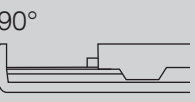

FOOT SIZE FUSSBREITE mm	SHAFT LENGTH SCHAFTLÄNGE mm	STANDARD FOOT STANDARDFUSS		FLAT FOOT FLACHFUSS	
		40° 	90° 	40° 	90° 
0,8	180	TGC-0	TGM-0	-	-
	200	TGA-0	TGK-0	-	-
1,0	180	TGC-1	TGM-1	TGD-1	TGN-1
	200	TGA-1	TGK-1	TGB-1	TGL-1
	250	TGE-1	TGO-1	TGF-1	TGP-1
	300	TGG-1	TGQ-1	TGH-1	TGR-1
	400	TGI-1	TGS-1	TGJ-1	TGT-1
1,5	180	TGC-7	TGM-7	TGD-7	TGN-7
	200	TGA-7	TGK-7	TGB-7	TGL-7
	250	TGE-7	TGO-7	TGF-7	TGP-7
	300	TGG-7	TGQ-7	TGH-7	TGR-7
	400	TGI-7	TGS-7	TGJ-7	TGT-7
2,0	180	TGC-2	TGM-2	TGD-2	TGN-2
	200	TGA-2	TGK-2	TGB-2	TGL-2
	250	TGE-2	TGO-2	TGF-2	TGP-2
	300	TGG-2	TGQ-2	TGH-2	TGR-2
	400	TGI-2	TGS-2	TGJ-2	TGT-2
2,5	180	TGC-8	TGM-8	TGD-8	TGN-8
	200	TGA-8	TGK-8	TGB-8	TGL-8
	250	TGE-8	TGO-8	TGF-8	TGP-8
	300	TGG-8	TGQ-8	TGH-8	TGR-8
	400	TGI-8	TGS-8	TGJ-8	TGT-8
3,0	180	TGC-3	TGM-3	TGD-3	TGN-3
	200	TGA-3	TGK-3	TGB-3	TGL-3
	250	TGE-3	TGO-3	TGF-3	TGP-3
	300	TGG-3	TGQ-3	TGH-3	TGR-3
	400	TGI-3	TGS-3	TGJ-3	TGT-3
3,5	180	TGC-9	TGM-9	-	-
	200	TGA-9	TGK-9	-	-
	250	TGE-9	TGO-9	-	-
	300	TGG-9	TGQ-9	-	-
	400	TGI-9	TGS-9	-	-
4,0	180	TGC-4	TGM-4	TGD-4	TGN-4
	200	TGA-4	TGK-4	TGB-4	TGL-4
	250	TGE-4	TGO-4	TGF-4	TGP-4
	300	TGG-4	TGQ-4	TGH-4	TGR-4
	400	TGI-4	TGS-4	TGJ-4	TGT-4
5,0	180	TGC-5	TGM-5	TGD-5	TGN-5
	200	TGA-5	TGK-5	TGB-5	TGL-5
	250	TGE-5	TGO-5	TGF-5	TGP-5
	300	TGG-5	TGQ-5	TGH-5	TGR-5
	400	TGI-5	TGS-5	TGJ-5	TGT-5
6,0	180	TGC-6	TGM-6	TGD-6	TGN-6
	200	TGA-6	TGK-6	TGB-6	TGL-6
	250	TGE-6	TGO-6	TGF-6	TGP-6
	300	TGG-6	TGQ-6	TGH-6	TGR-6
	400	TGI-6	TGS-6	TGJ-6	TGT-6

All punches with length 300 and 400 mm are calibrated / Alle Stanzen in den Längen 300 und 400 mm sind graduiert

*See page 6/6 / siehe Seite 6/6

CERAMO® **TURNUS***

ROTATABLE SHAFTS / DREHBARE SCHÄFTE

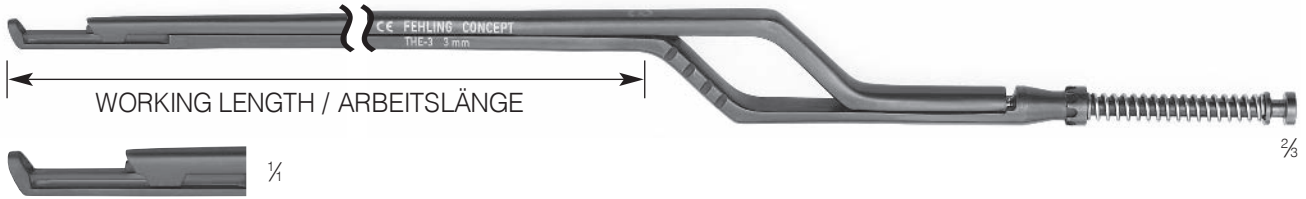

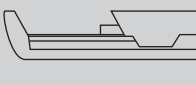
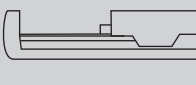
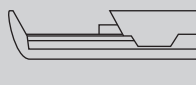
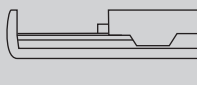
FOOT SIZE FUSSBREITE mm	WORKING LENGTH ARBEITSLÄNGE mm	STANDARD FOOT STANDARDFUSS		FLAT FOOT FLACHFUSS	
		40° 	90° 	40° 	90° 
1,0	110	THA-1	THK-1	THB-1	THL-1
	150	THC-1	THM-1	THD-1	THN-1
	180	THE-1	THO-1	THF-1	THP-1
1,5	110	THA-7	THK-7	THB-7	THL-7
	150	THC-7	THM-7	THD-7	THN-7
	180	THE-7	THO-7	THF-7	THP-7
2,0	110	THA-2	THK-2	THB-2	THL-2
	150	THC-2	THM-2	THD-2	THN-2
	180	THE-2	THO-2	THF-2	THP-2
2,5	110	THA-8	THK-8	THB-8	THL-8
	150	THC-8	THM-8	THD-8	THN-8
	180	THE-8	THO-8	THF-8	THP-8
3,0	110	THA-3	THK-3	THB-3	THL-3
	150	THC-3	THM-3	THD-3	THN-3
	180	THE-3	THO-3	THF-3	THP-3
4,0	110	THA-4	THK-4	THB-4	THL-4
	150	THC-4	THM-4	THD-4	THN-4
	180	THE-4	THO-4	THF-4	THP-4
5,0	110	THA-5	THK-5	THB-5	THL-5
	150	THC-5	THM-5	THD-5	THN-5
	180	THE-5	THO-5	THF-5	THP-5
6,0	110	THA-6	THK-6	THB-6	THL-6
	150	THC-6	THM-6	THD-6	THN-6
	180	THE-6	THO-6	THF-6	THP-6

*see page 6/6 / siehe Seite 6/6



SHAFT Ø SCHAFT Ø mm	SHAFT LENGTH SCHAFTLÄNGE mm	40° 
3,0	360	TGW-1
3,5	360	TGW-0

FOR ENDOSCOPY (NO EJECTOR)
FÜR ENDOSKOPIE (KEIN AUSWERFER)

*see page 6/6 / siehe Seite 6/6

CERAMO® **GENTLE**

DETACHABLE / ZERLEGBAR

BIG HANDLE AND STROKE
GROSSER GRIFF UND HUB





FOOT SIZE FUSSBREITE mm	SHAFT LENGTH SCHAFTLÄNGE mm	STANDARD FOOT STANDARDFUSS		FLAT FOOT FLACHFUSS
		40° GENTLE	40° GENTLE-“SINGER”	40° GENTLE
1,0	200	TIA-1	-	TIB-1
	250	TIC-1	-	TID-1
2,0	200	TIA-2	-	TIB-2
	250	TIC-2	-	TID-2
	300	TIE-2	-	TIF-2
3,0	200	TIA-3	TIG-3	TIB-3
	250	TIC-3	TIH-3	TID-3
	300	TIE-3	TIJ-3	TIF-3
4,0	200	TIA-4	TIG-4	TIB-4
	250	TIC-4	TIH-4	TID-4
	300	TIE-4	TIJ-4	TIF-4
5,0	200	TIA-5	TIG-5	TIB-5
	250	TIC-5	TIH-5	TID-5
	300	TIE-5	TIJ-5	TIF-5
6,0	200	TIA-6	TIG-6	TIB-6
	250	TIC-6	TIH-6	TID-6
	300	TIE-6	TIJ-6	TIF-6
7,0	200	TIA-8	-	-
8,0	200	TIA-7	-	-

CERAMO® **TRADITION X**

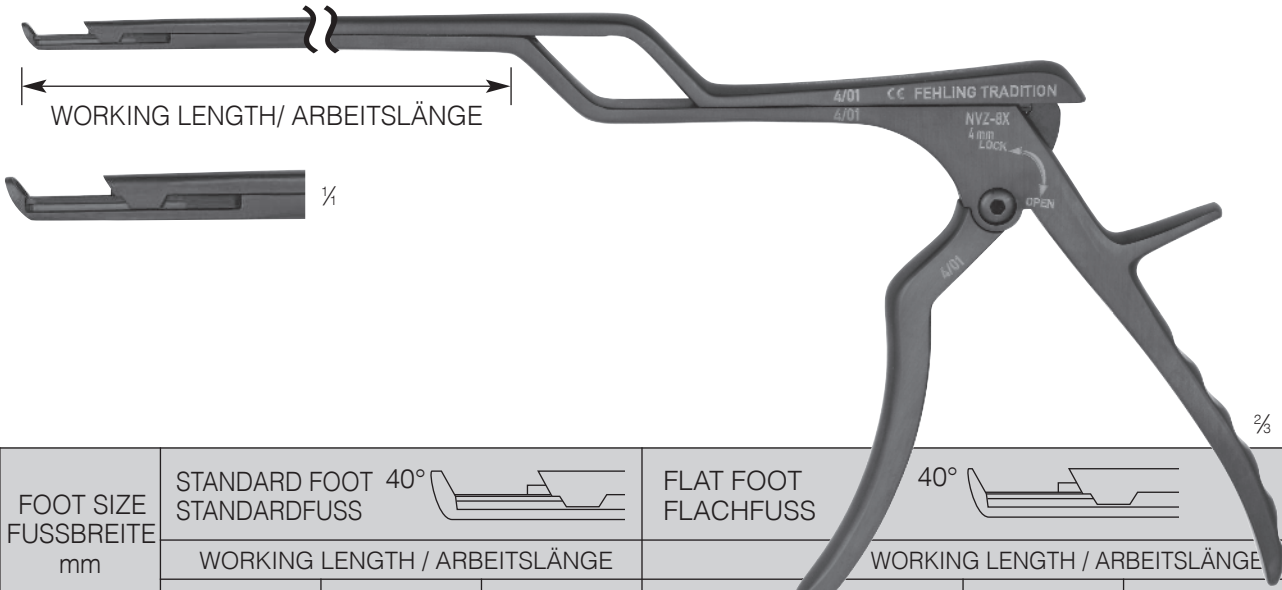

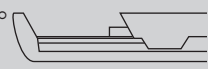
DETACHABLE / ZERLEGBAR



FOOT SIZE FUSSBREITE mm	STANDARD FOOT 40° STANDARDFUSS 			FLAT FOOT 40° FLACHFUSS 			
	WORKING LENGTH / ARBEITSLÄNGE			WORKING LENGTH / ARBEITSLÄNGE			
	110 mm	140 mm	180 mm	140 mm	160 mm	180 mm	200 mm
1,0	NUZ-9X	NVZ-1X	NVZ-0X	NVZ-6X	–	NVZ-3X	NVD-0X
2,0	NNU-0X	NVZ-2X	NVA-5X	NVZ-7X	NUZ-5X	NVZ-4X	NVD-1X
3,0	NNU-1X	NNU-4X	NNU-7X	NNX-4X	NUZ-6X	NVA-8X	NVD-6X
4,0	NNU-2X	NNU-5X	NNU-8X	NVZ-8X	NUZ-7X	NVZ-5X	–
5,0	NNU-3X	NNU-6X	NNU-9X	NVZ-9X	–	NVA-9X	–

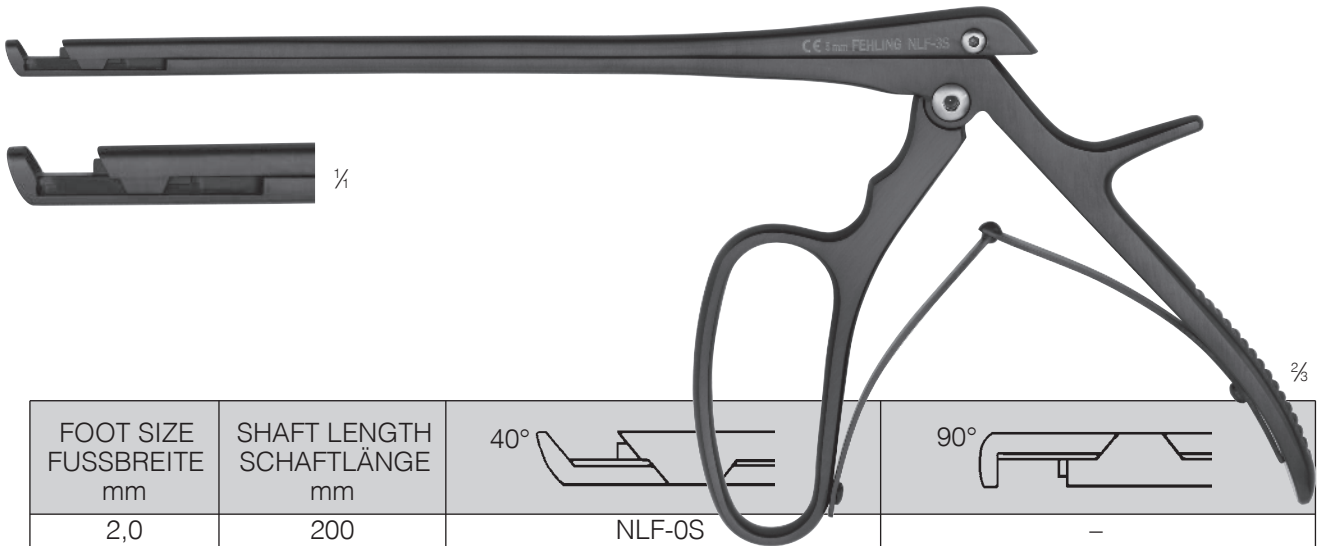

CERAMO® **FIST**

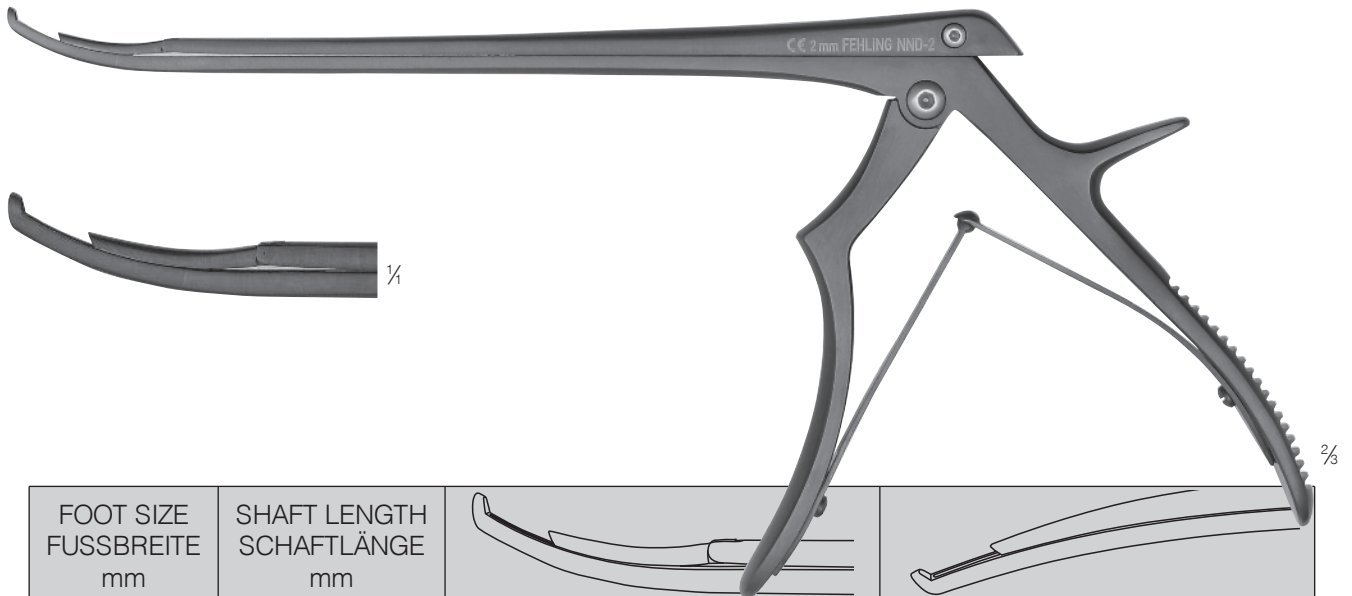

FOOT SIZE FUSSBREITE mm	SHAFT LENGTH SCHAFTLÄNGE mm	40° 	90° 
		2,0	200
3,0	200	NLF-1S	NLG-5S
	300	NLF-5S	NLH-1S
4,0	400	NLG-1S	NLH-5S
	200	NLF-2S	NLG-6S
	300	NLF-6S	NLH-2S
5,0	400	NLG-2S	NLH-6S
	200	NLF-3S	NLG-7S
	300	NLF-7S	NLH-3S
6,0	400	NLG-3S	NLH-7S
	200	NLF-4S	NLG-8S
	300	NLF-8S	NLH-4S
7,0	400	NLG-4S	NLH-8S
	300	NLF-9S	–

CERAMO® **SUBLAMINAR**

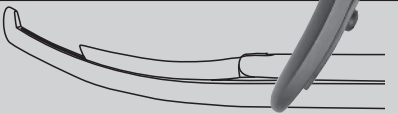

FOOT SIZE FUSSBREITE mm	SHAFT LENGTH SCHAFTLÄNGE mm		
2,0	200	NND-2	NVD-2
	250	NVC-2	NVE-2
3,0	200	NND-3	NVD-3
	250	NVC-3	NVE-3
4,0	200	NND-4	NVD-4
	250	NVC-4	NVE-4
5,0	200	NND-5	NVD-5
	250	NVC-5	NVE-5

CERAMO® **KERRISON**

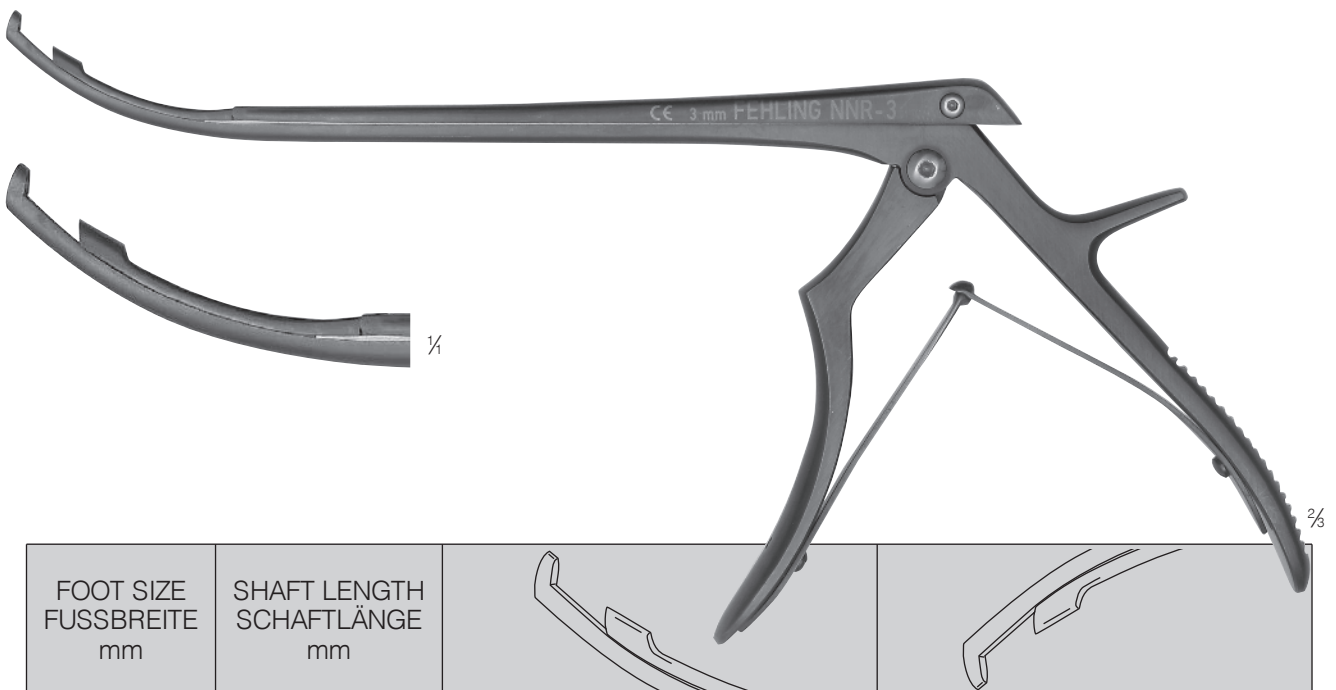

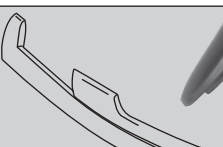
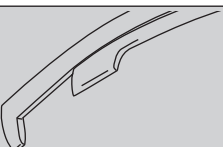
FOOT SIZE FUSSBREITE mm	SHAFT LENGTH SCHAFTLÄNGE mm		
2,0	200	NNR-9	-
3,0	200	NNR-3	NNR-6
4,0	200	NNR-4	NNR-7
	250	NNR-1	NNR-2
5,0	200	NNR-5	NNR-8

CERAMO® **TRADITION DIAMOND X**

FOR LIGAMENTS
FÜR LIGAMENTE

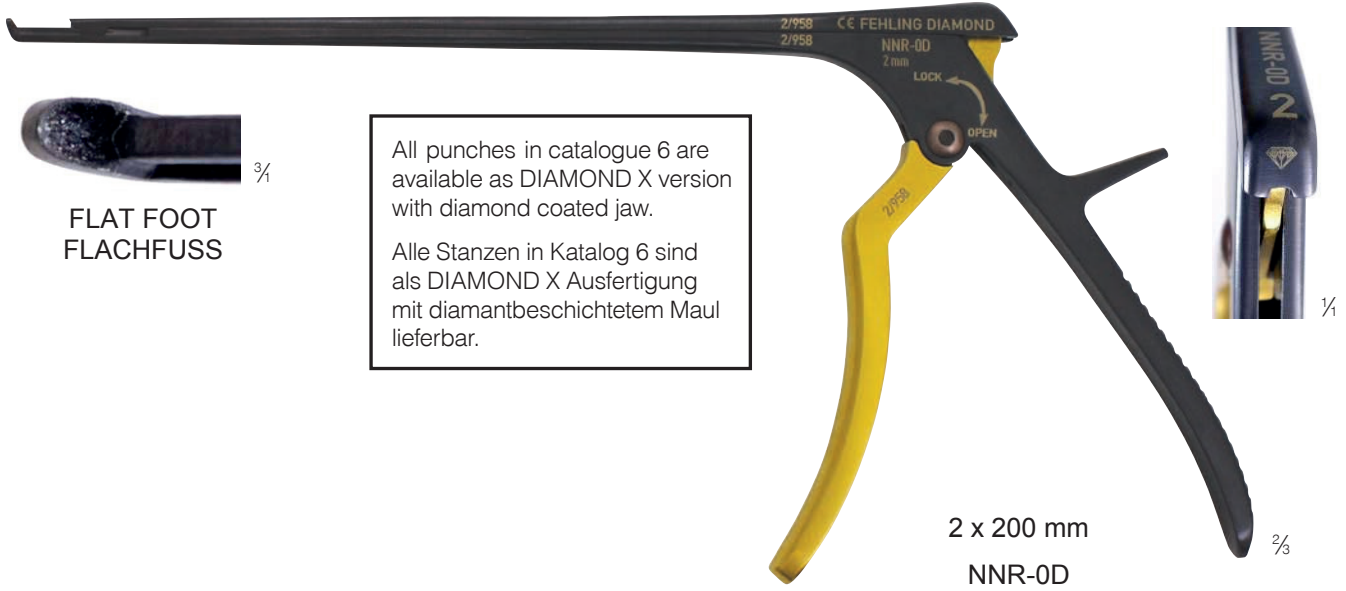

ACCESSORIES FOR PUNCHES
ZUBEHÖR FÜR STANZEN



STERILIZATION AND STORAGE TRAY FOR 10 PUNCHES
STERILISIERUNGS- UND AUFBEWAHRUNGSCONTAINER FÜR 10 STANZEN

515 x 250 x 150 mm

UCA-3

ACCESSORIES FOR DETACHABLE PUNCHES
ZUBEHÖR FÜR ZERLEGBARE STANZEN

FITTING DEVICES
MONTAGEVORRICHTUNGEN



CONCEPT X
TXW-7X



TRADITION X
TXW-6X



GENTLE
TXW-8X



SCREWDRIVER
SCHRAUBENDREHER
TXX-0X



SCREWDRIVER
STERILISABLE
SCHRAUBENDREHER
STERILISIERBAR
TXW-9X

CERAMO®



JAW WIDTH MAULBREITE mm	LENGTH LÄNGE mm			30°		30°	
		GRUMME	GRUMME X	GRUMME	GRUMME X	GRUMME	GRUMME X
2,0	120	NLO-2	NLO-2X	NLO-6	NLO-6X	NLN-6	NLN-6X
	160	NLT-2	NLT-2X	NLT-6	NLT-6X	NLV-2	NLV-2X
	180	NLU-2	NLU-2X	NLU-6	NLU-6X	NLV-6	NLV-6X
	200	NLX-2	NLX-2X	NLX-6	NLX-6X	-	-
	250	NLW-2	NLW-2X	-	NMJ-8X	-	-
	300	-	-	NLW-7	-	-	-
3,0	120	NLO-3	NLO-3X	NLO-7	NLO-7X	NLN-7	NLN-7X
	160	NLT-3	NLT-3X	NLT-7	NLT-7X	NLV-3	NLV-3X
	180	NLU-3	NLU-3X	NLU-7	NLU-7X	NLV-7	NLV-7X
	200	NLX-3	NLX-3X	NLX-7	-	-	-
	250	NLW-3	NLW-3X	-	NMJ-9X	-	-
4,0	120	NLO-4	NLO-4X	NLO-8	NLO-8X	NLN-8	NLN-8X
	160	NLT-4	NLT-4X	NLT-8	NLT-8X	NLV-4	NLV-4X
	180	NLU-4	NLU-4X	NLU-8	NLU-8X	NLV-8	NLV-8X
	200	NLX-4	NLX-4X	NLX-8	NLX-8X	-	-
	250	NLW-4	NLW-4X	-	NMK-0X	-	-
5,0	120	NLO-5	NLO-5X	NLO-9	NLO-9X	NLN-9	NLN-9X
	160	NLT-5	NLT-5X	NLZ-9	NLZ-9X	NLV-5	NLV-5X
	180	NLU-5	NLU-5X	NLU-9	NLU-9X	NLV-9	NLV-9X
	200	NLX-5	NLX-5X	NLX-9	NLX-9X	-	-
	250	NLW-5	NLW-5X	NLW-0	NLW-0X	-	-
6,0	120	NLO-0	-	-	-	-	-
	250	NLW-6	NLW-6X	-	-	-	-

ACCESSORIES FOR GRUMME X RONGEURS
ZUBEHÖR FÜR GRUMME X RONGEURE

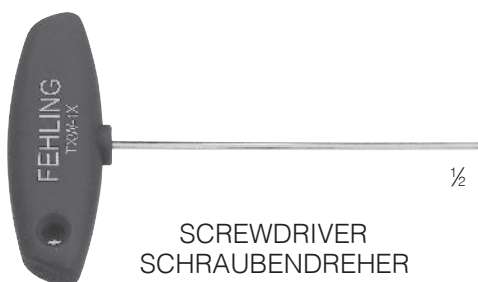

SCREWDRIVER
SCHRAUBENDREHER

TXW-1X





SCREWDRIVER STERILISABLE
SCHRAUBENDREHER STERILISIERBAR

TXW-2X

CERAMO®

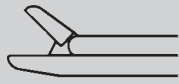

JAW WIDTH MAULBREITE mm	LENGTH LÄNGE mm				
		RICHTER	RICHTER X	RICHTER	RICHTER X
1,0	180	NKR-2	NKR-2X	NKR-4	NKR-4X
1,5	180	NKR-1	NKR-1X	NKR-3	NKR-3X



JAW WIDTH MAULBREITE mm	LENGTH LÄNGE mm	
10	200	TOV-1
12	200	TOV-2

CERAMO®



JAW WIDTH MAULBREITE mm	LENGTH LÄNGE mm				
		FERRIS-SMITH	FERRIS-SMITHX	FERRIS-SMITH	FERRIS-SMITHX
2,0	180	TOC-0	TOC-0X	TOF-0	TOF-0X
	200	TOG-0	TOG-0X	TOH-0	TOH-0X
	250	TOI-0	TOI-0X	TOJ-0	TOJ-0X
	300	TOK-0	TOK-0X	TON-0	TON-0X
2,5	200	TOG-7	TOG-7X	–	–
3,0	180	TOC-1	TOC-1X	TOF-1	TOF-1X
	200	TOG-1	TOG-1X	TOH-1	TOH-1X
	250	TOI-1	TOI-1X	TOJ-1	TOJ-1X
	300	TOK-1	TOK-1X	TON-1	TON-1X
	400	TOO-3	TOO-3X	TOO-8	TOO-8X
3,5	200	TOG-8	TOG-8X	–	–
4,0	180	TOC-2	TOC-2X	TOF-2	TOF-2X
	200	TOG-2	TOG-2X	TOH-2	TOH-2X
	250	TOI-2	TOI-2X	TOJ-2	TOJ-2X
	300	TOK-2	TOK-2X	TON-2	TON-2X
	400	TOO-4	TOO-4X	TOO-9	TOO-9X
5,0	180	TOC-3	TOC-3X	TOF-3	TOF-3X
	200	TOG-3	TOG-3X	TOH-3	TOH-3X
	250	TOI-3	TOI-3X	TOJ-3	TOJ-3X
	300	TOK-3	TOK-3X	TON-3	TON-3X
	400	TOO-5	TOO-5X	–	–
6,0	180	TOC-4	TOC-4X	TOF-4	TOF-4X
	200	TOG-4	TOG-4X	TOH-4	TOH-4X
	250	TOI-4	TOI-4X	TOJ-4	TOJ-4X
	300	TOK-4	TOK-4X	TON-4	TON-4X
7,0	180	TOC-5	TOC-5X	TOF-5	TOF-5X
	200	TOG-5	TOG-5X	TOH-5	TOH-5X
	250	TOI-5	TOI-5X	TOJ-5	TOJ-5X
	300	TOK-5	TOK-5X	TON-5	TON-5X
8,0	180	TOC-6	TOC-6X	TOF-6	TOF-6X
	200	TOG-6	TOG-6X	TOH-6	TOH-6X
	250	TOI-6	TOI-6X	TOJ-6	TOJ-6X
	300	TOK-6	TOK-6X	TON-6	TON-6X

CERAMO®

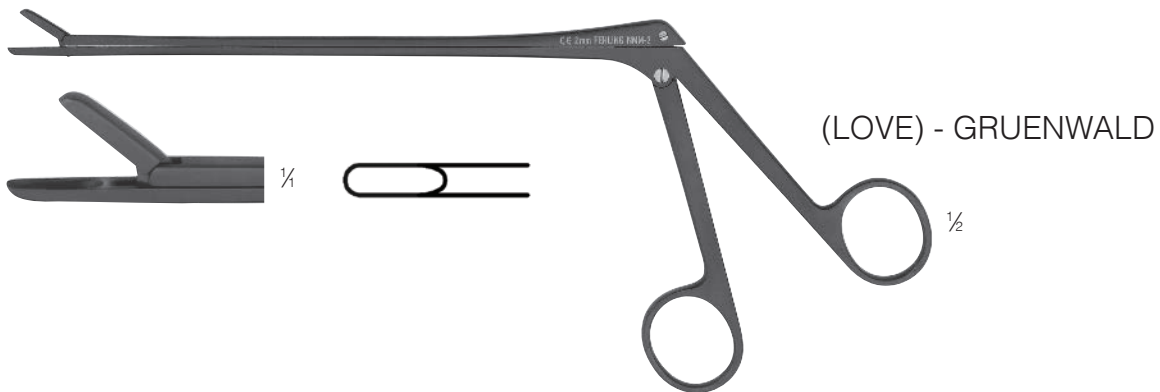

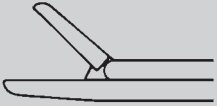
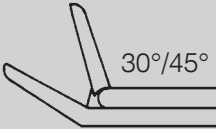
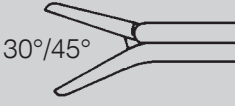
JAW WIDTH MAULBREITE mm	LENGTH LÄNGE mm			
1,0	180	NMM-1	NMN-1	NMO-1
	200	NLP-1	NMN-0	-
2,0	160	NMJ-2	NMK-2	NML-2
	180	NMM-2	NMN-2	NMO-2
	250	NMP-2	NMQ-2	NMR-2
	300	NMW-9	NMW-7 (45°)	NMW-8 (45°)
	400	NMK-6	NMT-6 (45°)	NMT-8 (45°)
3,0	160	NMJ-3	NMK-3	NML-3
	180	NMM-3	NMN-3	NMO-3
	250	NMP-3	NMQ-3	NMR-3
	300	NMW-3	NMW-1 (45°)	NMW-2 (45°)
	400	NMK-7	NMT-7 (45°)	NMT-9 (45°)
4,0	160	NMJ-4	NMK-4	NML-4
	180	NMM-4	NMN-4	NMO-4
	250	NMP-4	NMQ-4	NMR-4
	300	NMU-5	NMU-1 (45°)	NMU-2 (45°)
	400	NMK-8	NMU-3 (45°)	NMU-4 (45°)
5,0	160	NMJ-5	NMK-5	NML-5
	180	NMM-5	NMN-5	NMO-5
	250	NMP-5	NMQ-5	NMR-5
	300	NMW-6	NMW-4 (45°)	NMW-5 (45°)
	400	NMK-9	NMU-8 (45°)	NMU-9 (45°)

CERAMO®

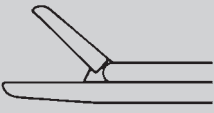
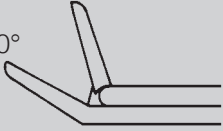
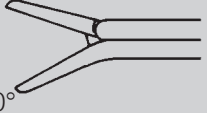

JAW WIDTH MAULBREITE mm	LENGTH LÄNGE mm		30° 	30° 
2,5	130	NMA-2	NMB-2	NMC-2
	160	NMD-2	NME-2	NMF-2
3,0	130	NMA-3	NMB-3	NMC-3
	160	NMD-3	NME-3	NMF-3
4,0	130	NMA-4	NMB-4	NMC-4
	160	NMD-4	NME-4	NMF-4
5,0	130	NMA-5	NMB-5	NMC-5
	160	NMD-5	NME-5	NMF-5
6,0	130	NMA-6	NMB-6	NMC-6
	160	NMD-6	NME-6	NMF-6

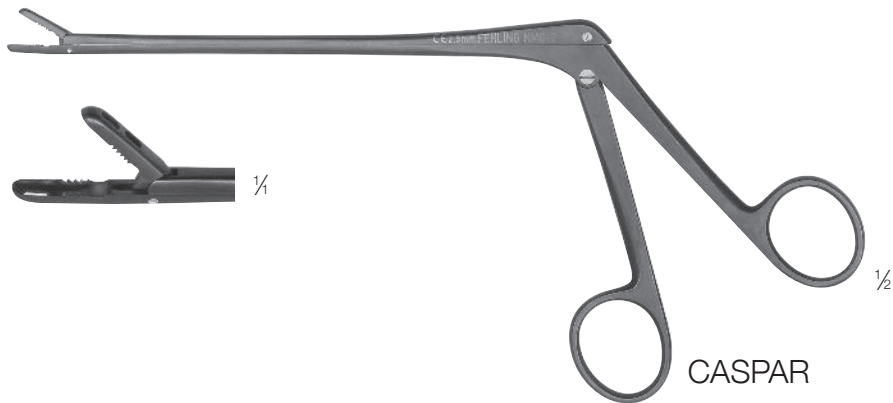

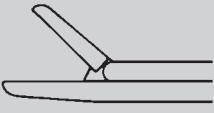
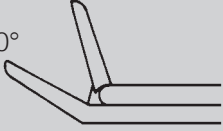
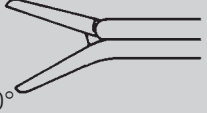
JAW WIDTH MAULBREITE mm	LENGTH LÄNGE mm		30° 	30° 
2,0	160	NMG-1	NMH-1	NMI-1
	180	NMG-0	NMH-0	NMI-0
2,5	160	NMG-2	NMH-2	NMI-2
	180	NMG-6	NMH-6	NMI-6
3,0	160	NMG-3	NMH-3	NMI-3
	180	NMG-7	NMH-7	NMI-7
4,0	160	NMG-4	NMH-4	NMI-4
	180	NMG-8	NMH-8	NMI-8
5,0	160	NMG-5	NMH-5	NMI-5
	180	NMG-9	NMH-9	NMI-9

CERAMO®

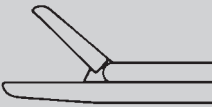
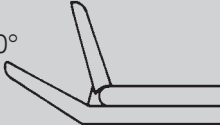
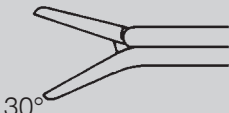

JAW WIDTH MAULBREITE mm	LENGTH LÄNGE mm		30° 	
3,0	200	NLA-1	NLB-5	NLD-1
	300	NLA-5	NLC-1	NLD-5
	400	NLB-1	NLC-5	NLE-1
4,0	200	NLA-2	NLB-6	NLD-2
	300	NLA-6	NLC-2	NLD-6
	400	NLB-2	NLC-6	NLE-2
5,0	200	NLA-3	NLB-7	NLD-3
	300	NLA-7	NLC-3	NLD-7
	400	NLB-3	NLC-7	NLE-3
6,0	200	NLA-4	NLB-8	NLD-4
	300	NLA-8	NLC-4	NLD-8
	400	NLB-4	NLC-8	NLE-4

All rongeurs with length 300 and 400 mm are calibrated / Alle Rongeur in den Längen 300 und 400 mm sind graduiert

ENDOSCOPIC GRASPING FORCEPS
ENDOSKOPISCHE FASSZANGE

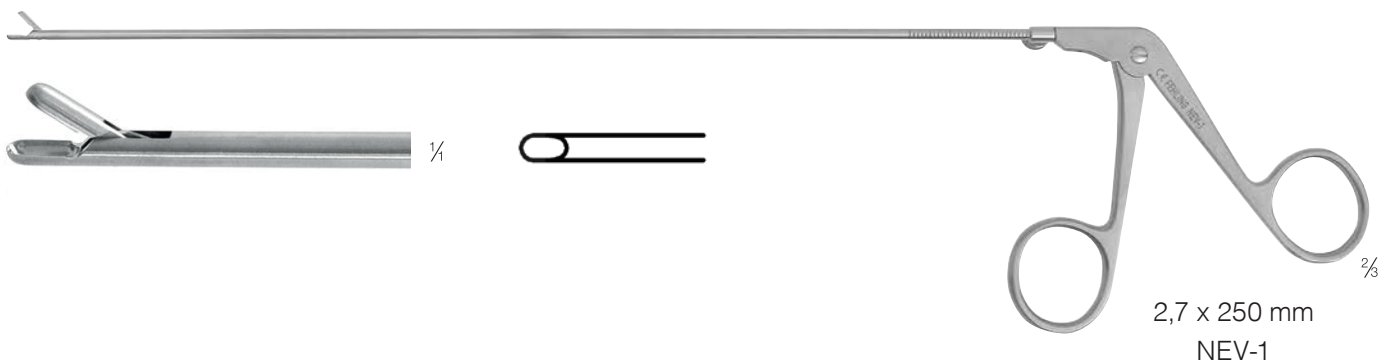

CERAMO®



BÖHLER
150 mm

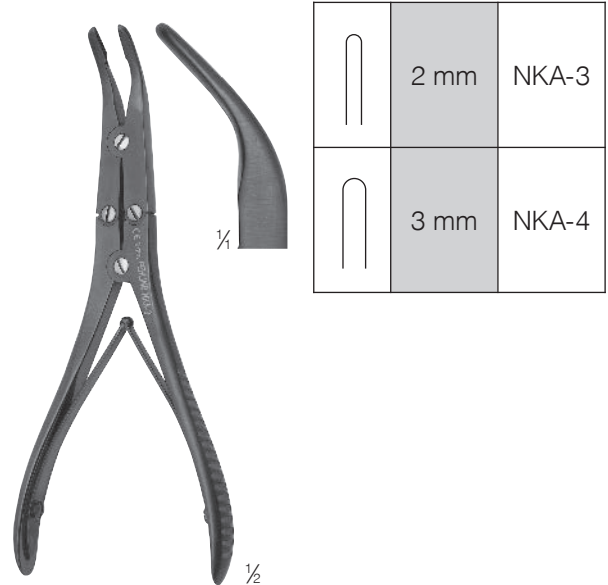

BÖHLER
150 mm



BEYER
180 mm
NKA-5



ZAUFAL-JANSEN
180 mm
NKA-6





RUSKIN
190 mm
NKA-7

CERAMO®

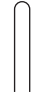

MARQUARDT
200 mm



	2 mm	NKA-8
	3 mm	NKA-9



RUSKIN
230 mm
NKB-7





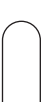

SMITH-PETERSON
240 mm

	3 mm	NKB-1
	4 mm	NKB-2
	5 mm	NKB-3





SMITH-PETERSON
240 mm

	2 mm	NKB-0
	3 mm	NKB-4
	4 mm	NKB-5
	5 mm	NKB-6

CERAMO®

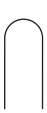

MEGA-LUER
400 mm

	3 mm	NKC-7
	5 mm	NKC-8
	8 mm	NKC-9



STILLE-RUSKIN
230 mm
NKB-8



LUER-STILLE
270 mm
NKC-4



LUER-STILLE
220 mm

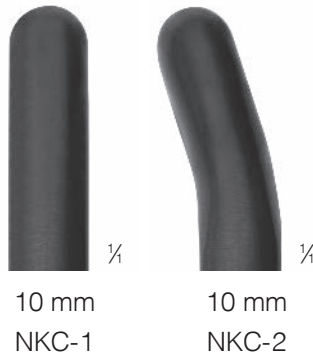

10 mm
NKC-1

10 mm
NKC-2







SEMB
230 mm
NKC-3

CERAMO®

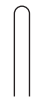





LEKSELL
230 mm

	2 mm	NKD-0
	3 mm	NKD-6
	4 mm	NKD-7
	6 mm	NKD-8
	8 mm	NKD-9







LEKSELL
230 mm

	3 mm	NKF-6
	4 mm	NKF-7
	6 mm	NKF-8
	8 mm	NKF-9

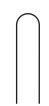

STILLE
230 mm

	2 mm	NKD-1
	3 mm	NKD-2
	4 mm	NKD-3
	6 mm	NKD-4
	8 mm	NKD-5

CERAMO®



BÖHLER
150 mm

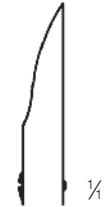

NKK-1



NKK-2



RUSKIN-LISTON
190 mm

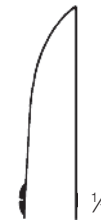

NKK-3



NKK-4



LISTON

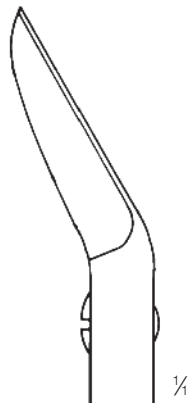

235 mm

NKK-5

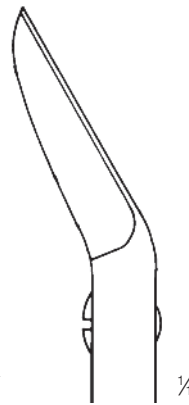

275 mm

NKK-6



WIRE EXTRACTION PLIER
DRAHTAUSZUGSZANGE

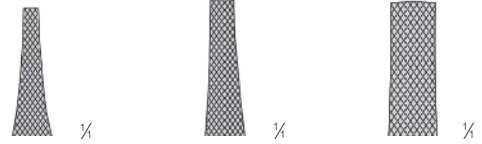

LENGTH LÄNGE	EXTRA DELICATE EXTRA FEIN	DELICATE FEIN	LARGE BREIT
150 mm	LAE-6	-	LAE-8
180 mm	LAE-4	LAE-7	LAE-9

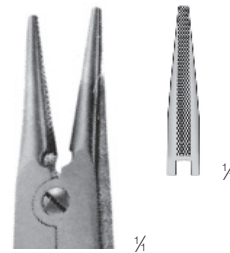

ROUND PLIERS
RUNDZANGE
180 mm
LAH-7